

Top View

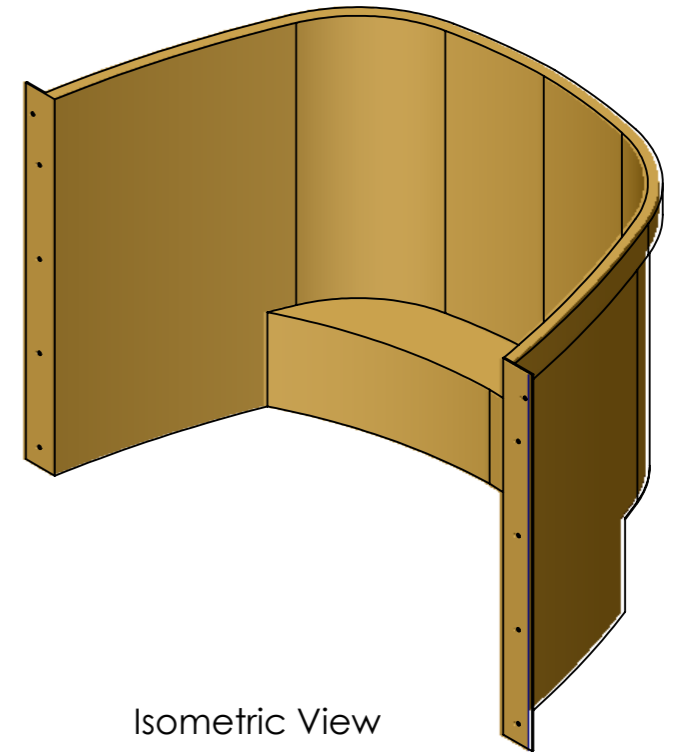

Isometric View



Front View

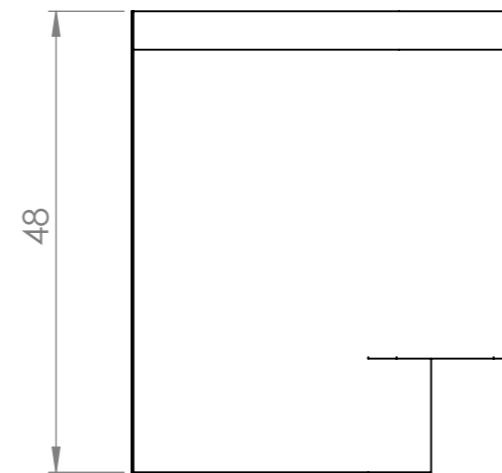

Side View

UNLESS OTHERWISE SPECIFIED: DIMENSIONS ARE IN MILLIMETERS SURFACE FINISH: TOLERANCES: LINEAR: ANGULAR:				FINISH:		DEBUR AND BREAK SHARP EDGES		DO NOT SCALE DRAWING		REVISION	
								RockWell, LLC			
								TITLE: Premier Window Well 66 x 39 x 48			
								DWG NO. WPT-663948		A3	
								SCALE:1:20		SHEET 1 OF 1	